



WATER PARK SLIDES

Water Park
Slides





WATER PARK SLIDES

Water Park
Slides

WATER PARK SLIDES

Free fall water slides	546
Open & closed turning slide	547
High speed float slides	548
High speed open & colosed slides	549
Water play station	550
Multi racer slides	553
Thriller slides	554
Funnel Slides	555
Spider Slides	556



Water Park Slides



► Water Park Slides



We Provide

We offer the widest range of water park equipment and introduce the latest technology and innovative products. International quality at competitive price Customized and innovative designs Assured quality and on time delivery Personalized service Guaranteed customer satisfaction

Complete Solution

Designing and planing | Themetization | Consulting | Manufacturing | Installation | After Sale Services | Turnkey Development



Water Park Slides



Water Park Slides



► Water Park Slides



Free Fall Water Slide

Width of slide	0.92 m
Height	6m-18m
No of rider	1
Rider capacity	150to 270/h
Transport Medium	Body
Exit	Pool/Sofa landing
Water Requirement	1500LPM

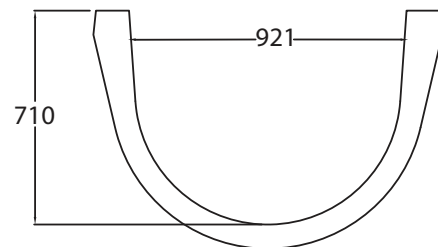
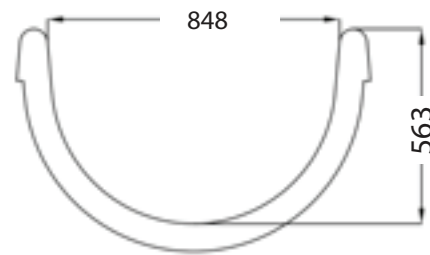

Body wave slides

Width of slide	0.92 m
Height	6m-18m
No of rider	1
Rider capacity	150to 270/h
Transport Medium	Body
Exit	Pool/Sofa landing
Water Requirement	1500LPM



Water Park Slides



► Open Body Turning Slides

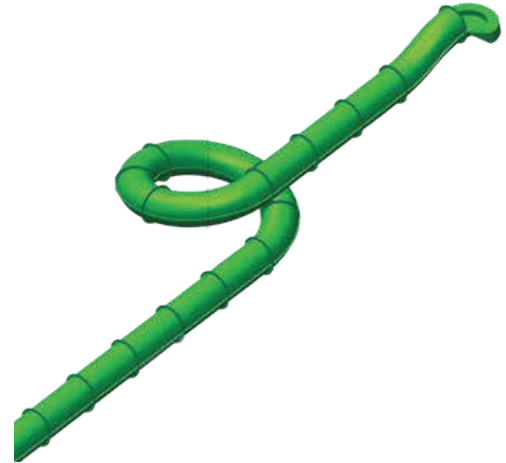
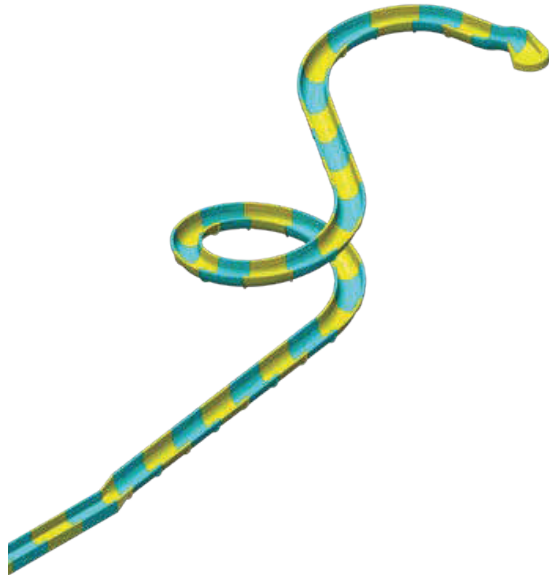

Open Body Turning Slide

Width of slide	0.92 m
Height	3m-12m
No of rider	1
Rider capacity	150to 270/h
Transport Medium	Body
Exit	Pool/Sofa landing
Water Requirement	1500LPM

Closed Body Tunnel Slide

Width of slide	0.87 m
Height	3m-12m
No of rider	1
Rider capacity	150to 270/h
Transport Medium	Body
Exit	Pool/Sofa landing
Water Requirement	1500LPM

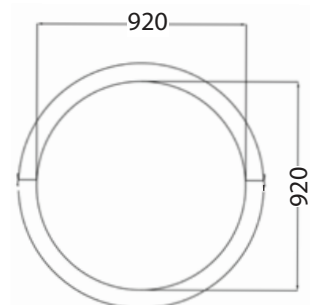
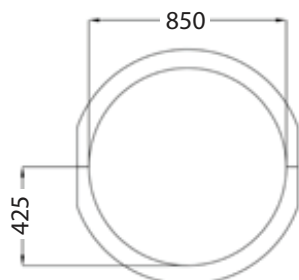
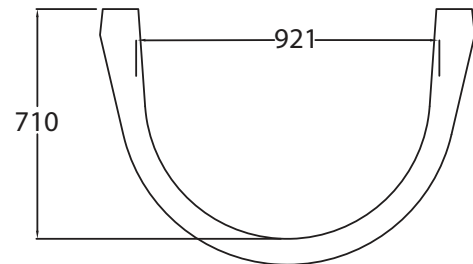
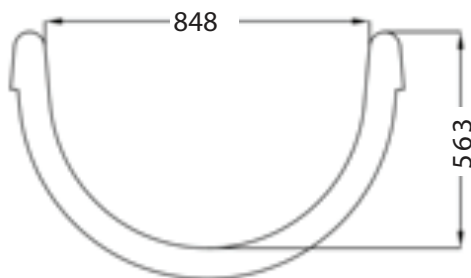

Water Park Slides



► High Speed Float Slides

High Speed Float Slide	
Width of slide	1.4m
Height	9m-18m
No of rider	1-2
Rider capacity	240to 340/h
Transport Medium	Float
Exit	Pool/Sofa landing
Water Requirement	2500LPM

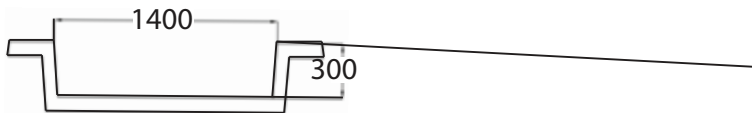
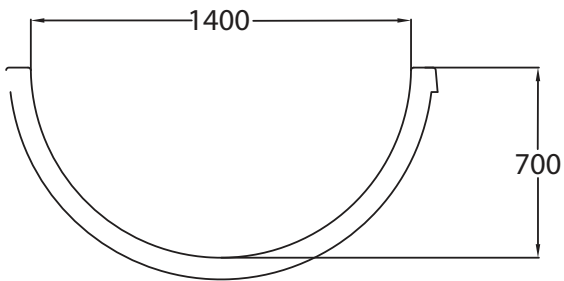

Water Park Slides



Water Park Slides



► High Speed Open & Closed Float Slides

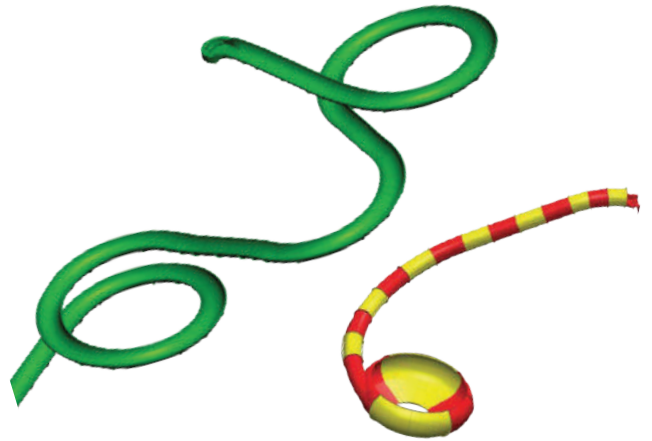
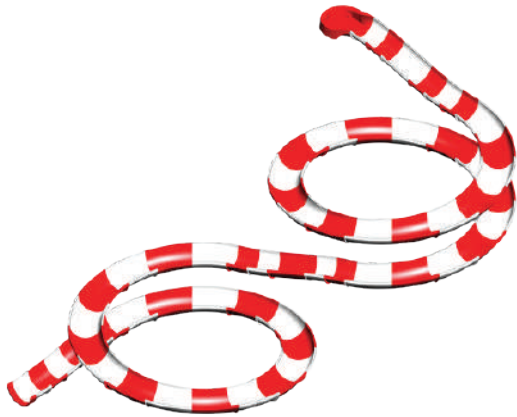

High Speed Open and Closed Float Slide

Width of slide	1.3m
Height	9m-18m
No of rider	1-2
Rider capacity	150to 250/h
Transport Medium	Float
Exit	Pool/Sofa landing
Water Requirement	2500LPM

Body Bowl Tornado

Width of slide	0.87m
Dia of bowl	6.2m
Height	6m-9m
No of rider	1
Rider capacity	150/h
Transport Medium	Body
Exit	Pool Landing
Water Requirement	2500LPM

Family slide

Width of slide	2.4m
Height	3m-6m
No of rider	4-8
Rider capacity	240-300/h
Transport Medium	Body
Exit	Pool Landing
Water Requirement	1500LPM

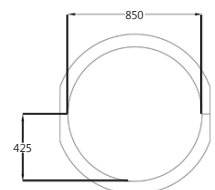
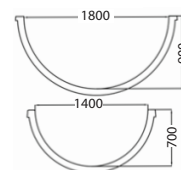
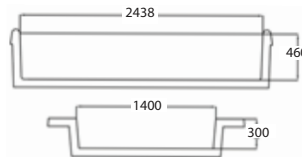
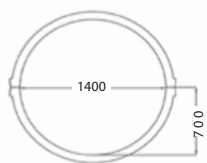
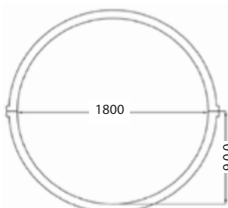
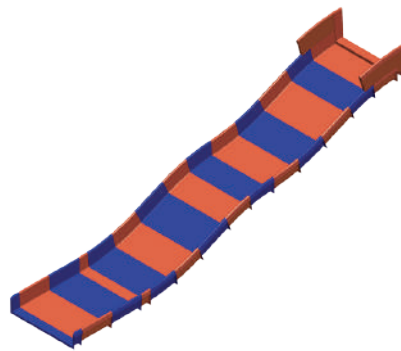

Water Play Station



► Water Play Station

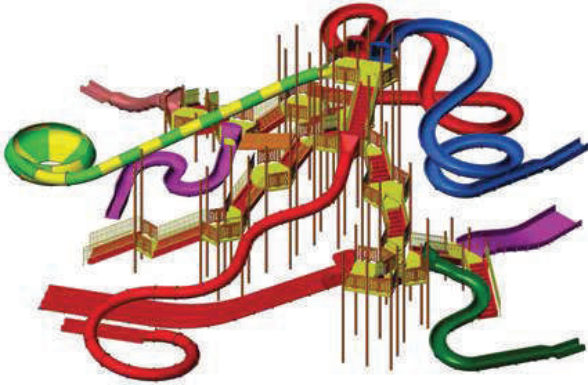

Water Play Station

Age Group	5-60 Years
Equipment and area	39m-42m
Minimum pool area	42m/45m
Maximum slide elevation	10.1
Maximum structure elevation	13.1
No of slide	9
Total feature including jets	200 Minimum
Required water flow	20,000LPM



Water Park Slides



Water Play Station



► Water Play Station

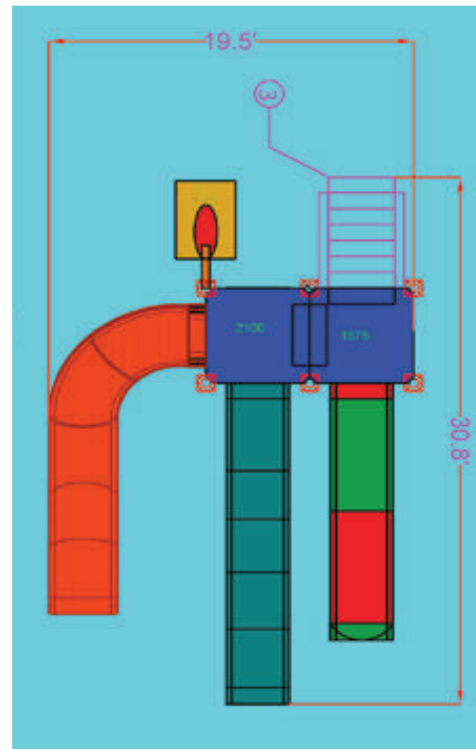
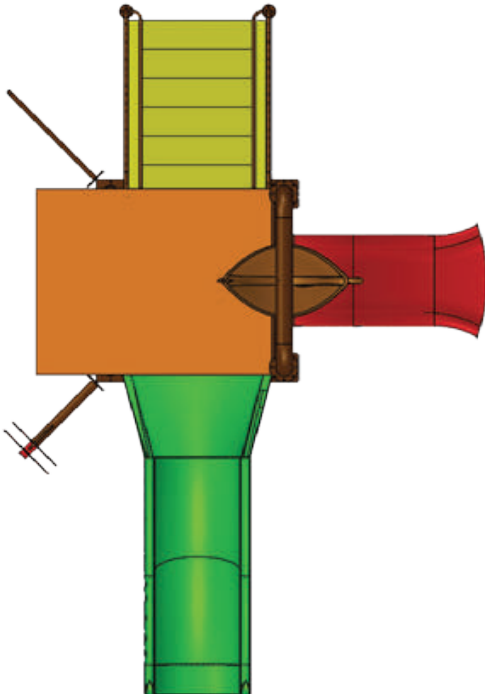

1 Platform

Age Group	3-12 Years
Equipment and area	7m-5m
Minimum pool area	10m/8m
Maximum slide elevation	1.05
Maximum structure elevation	6m
No of slide	2
Total feature including jets	5 Minimum
Required water flow	1500 LPM

2 Platform

Age Group	3-12 Years
Equipment and area	13m-6m
Minimum pool area	16m / 9m
Maximum slide elevation	2.1
Maximum structure elevation	5.1m
No of slide	3
Total feature including jets	8 Minimum
Required water flow	3000 LPM



Water Play Station



► Water Play Station



7 Platform

Age Group	5-60Years
Equipment and area	23m-14m
Minimum pool area	26m / 17m
Maximum slide elevation	6.3m
Maximum structure elevation	9.3m
No of slide	5
Total feature including jets	55 Minimum
Required water flow	10,000 LPM

8 Platform

Age Group	5-60Years
Equipment and area	27m-18m
Minimum pool area	30m / 21m
Maximum slide elevation	5.2m
Maximum structure elevation	8.2m
No of slide	6
Total feature including jets	60 Minimum
Required water flow	12000 LPM



12 Platform

Age Group	5-60Years
Equipment and area	28m-28m
Minimum pool area	31m / 31m
Maximum slide elevation	6.3m
Maximum structure elevation	9.3m
No of slide	8
Total feature including jets	75 Minimum
Required water flow	12000 LPM

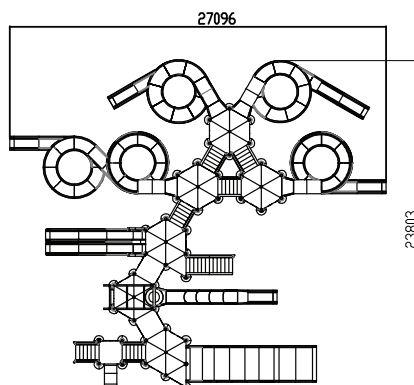

Water Play Station



► Multi Racer Slides

Multi Racer Slide	
Width of slide	0.67m
No of Lanes	3-7
Height	9-12m
No of rider	1 per lane
Rider capacity	10-120 per lane
Transport Medium	Head first matt
Exit	Pool sofa landing
Confirms	ASTM/EN
Water Requirement	per lane 1000LPM

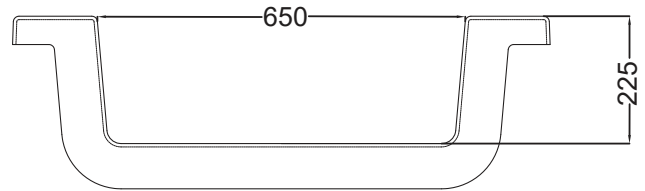

Water Play Station



► Thriller Slide

Thriller Slide	
Width of slide	3m
Height	9-18m
No of rider	4 per lane
Rider capacity	170-270 per lane
Transport Medium	Raft
Exit	Pool sofa landing
Water Requirement	Per lane 3500LPM

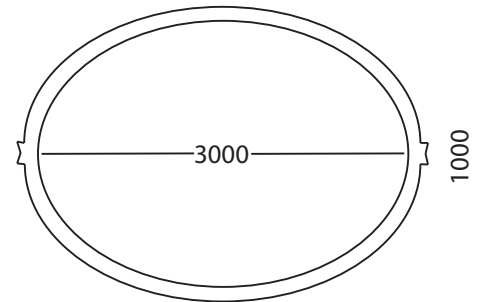
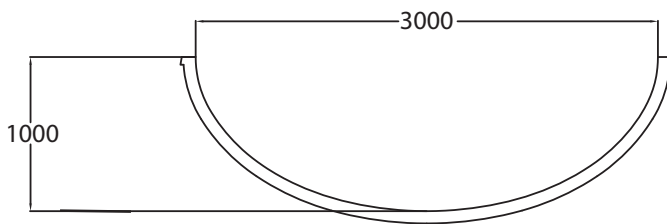

Water Play Station



► Funnel Slide



Funnel Slide

Width of slide	12m
Height	9-18m
No of rider	2 per lane
Rider capacity	150-270 per lane
Transport Medium	Raft
Exit	Pool sofa landing
Water Requirement	Per lane 3000LPM

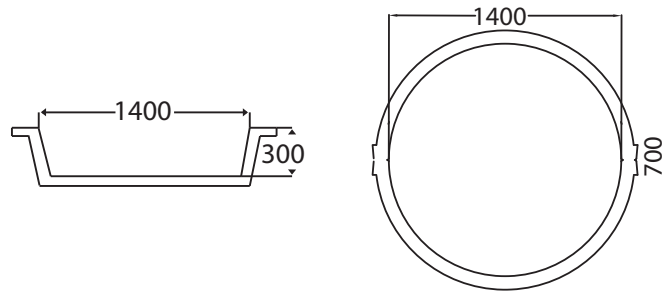

Water Play Station



► Spider Slide

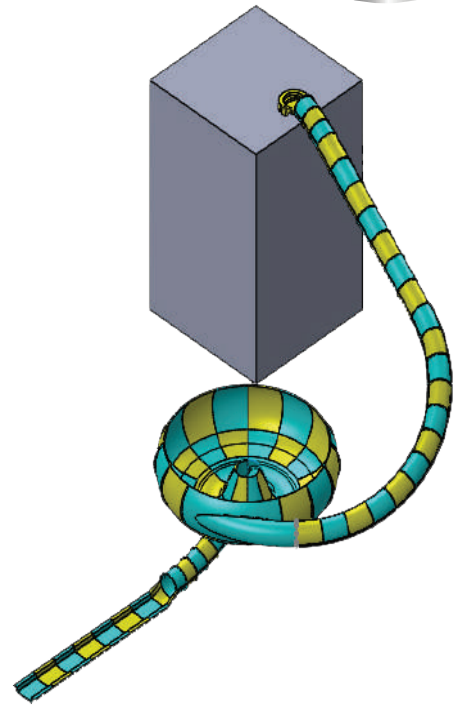
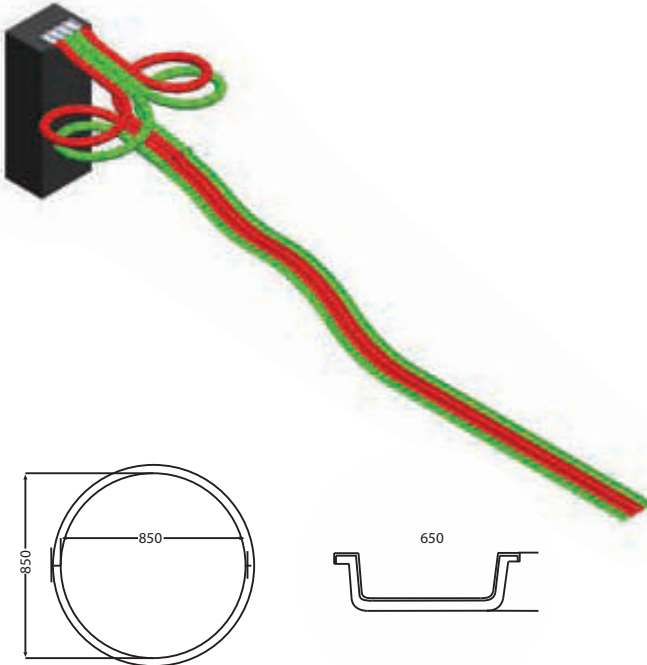

Spider Slide	
Width of slide	0.91m
Height	9-18m
No of rider	1 per lane
Rider capacity	170-270 per lane
Transport Medium	Matt / Head down first
Exit	Pool sofa landing
Water Requirement	Per lane 1500LPM

Thunder Bowl	
Width of slide	1.3m
Dia of Bowl	12m
Height	12-15m
No of rider	2
Rider capacity	240-300/hr
Transport Medium	Float
Exit	Pool sofa landing
Water Requirement	Per lane 8000LPM

